



SUMMA ROLL CUTTERS

S One | S Class 2 Series

**World renowned vinyl
and contour cutters**

A large, industrial-grade Summa roll cutter is shown in a side profile. It is a dark grey or black machine with a long, horizontal cutting bed. A roll of material is being processed, with a portion of it being cut and hanging down. The machine has a control panel on the right side with a small digital display. The background is a solid blue color with a white diagonal line separating the machine from the text area.

Summa

Summa.com | #SummaFinish

ABOUT SUMMA

Summa is a manufacturer of innovative cutting equipment that helps companies and people to finish their applications to the highest standards. Delivering outstanding quality conforming these high standards, has secured the Summa reputation for legendary performance.

Companies from all over the world use Summa cutting solutions for products in the printing, signage, display, apparel and packaging industry. With the cutting solutions from Summa your business is future-proof for many years to come.

[Summa.com](https://www.summa.com) | [#SummaFinish](https://twitter.com/SummaFinish)



About Summa **02**

Introduction of Summa Vinyl Cutters **04**

The Summa vinyl cutters are developed to grow with your business. Enjoy the countless possibilities all in one machine.

Summa S One Cutters **06**

Multiple models with innovative and future-proof features available at your fingertips

Models **08**

Serie specifics: Tools & Media Handling **12**

Technical Specifications **14**

Order Codes **15**

Summa S Class 2 cutters **16**

Multiple models with innovative and future-proof features available at your fingertips

Models **18**

Serie specifics: Tools & Media Handling **23**

Technical Specifications **26**

Order Codes **27**

Summa GoSign Software **28**

Powerful, in-house developed software tailored to the Summa roll cutter series

SUMMA VINYL CUTTERS, MADE TO LAST

Summa offers two advanced vinyl roll cutting product lines based on over 30 years of experience in building the world's very best cutting plotters: the Summa S One Series and Summa S Class 2 Series.

Both series are designed on a foundation of rock-solid reliability and outstanding expertise. They feature the highest quality engineering and most advanced cutting technology to deliver high-end contour cutting accuracy for printed graphics.

A Summa vinyl cutter is your first choice roll cutter where value and reliability are top of mind. Equipped with smart technologies to help you finish your jobs flawlessly. Enjoy the easy-to-use features to tailor your cutting workflow most efficiently.



S Class 2 Series and S One Series

Applications

The Summa roll cutter series are designed to deliver a wide range of applications for the Sign & Display market. Achieve perfectly cut stickers, traffic signs, billboards and so on with the S Class 2 and S One roll cutters now and for many years to come!

S Sign & Display

The world of Sign and Display is broad and versatile. Summa vinyl cutting solutions can optimise your print & cut workflow, meet your customers' deadlines and deliver perfectly finished end-products.

- (One-off) Stickers
- Labels
- Window Stickers
- Vehicle lettering and graphics
- Window lettering
- Flock/Flex templates
- Intricate small letters/designs
- Technical textiles

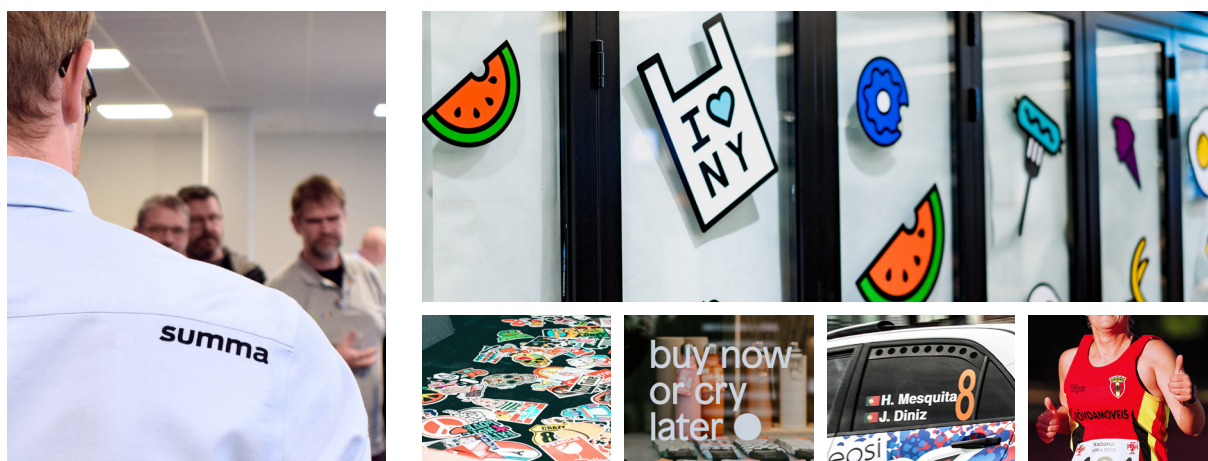

“Thanks to the use of the Summa vinyl cutter, we are able to create new opportunities and solutions, such as the processing of nautic sails. This particular substrate is a special textile, which is very hard and rigid to print and cut. In the past, we didn't succeed in processing them properly. But thanks to Summa's expertise – in both product and service – we are now able to deliver these sails with great finishing results.”

/ Industria Graphica FG about investing in a Summa S Class 2 T160



SUMMA S ONE SERIES, MADE TO GROW AT YOUR BUSINESS' PACE

With the S One Series, Summa offers a future-proof and reliable cutting product line, designed on the basis of years of experience, up-to-date techniques and by listening carefully to the customers' cutting needs. Various types of roll stock such as flock, vinyl and soft sheet materials can be processed efficiently and rapidly. A multitude of intelligent features combined with sleek ergonomics make the S One Series the ideal vinyl cutter to grow with your business.



Summa S One Series

The One to change the game

The S One Series is the next step in growing your business and was designed with a focus on ergonomics and simplicity in usage. An extremely fast OPOS sensor system compensates for any deformation of the print and increases the speed by which registration marks are read. An efficient drag knife offers a pressure of 600 grams, enabling to cut laminated designs with ease. The sophisticated OPOS Xtra feature allows to process most intricate small sticker jobs with the highest accuracy.

Summa's legendary tracking system allows to process job after job, cutting a complete roll up to 8 meters without reloading. The very durable titanium coated grit rollers assure you can work intensively for many years with the best tracking system available on the market. Extra internal intelligence minimises human errors and operator intervention.

State-of-the-art engineering, sophisticated GoSign software and versatile enhancement options have been combined to deliver unmatched performances. This is what makes the S One your first choice cutter where value and reliability are top of mind.

Key features

The S One Series is available in different sizes and different configurations. However, all units have basic features in common, each of which contributing to the strength, reliability and ease-of-use of the cutter.

Advanced cutting technology

The S One Series offers you leading-edge cutting technology without compromise. Up-to-date techniques deliver highest contour cutting accuracy for printed graphics. This makes the S One roll cutter a flexible and future-proof unit. The perfect companion for your business!

Ease-of-use

Enjoy enhanced ease-of-use with integrated intelligent features, such as an intuitive touchscreen, blue mechanical parts for easy navigation and easy connectivity to most common computers in the market.

Summa GoSign software

GoSign is your first choice cutting software designed for the Summa roll cutters. Manage your preferred workflow with great flexibility and automated cutting options, custom configuration of action sets, easy plug-ins for design programs and much more.

Legendary performance

The S One Series is built on Summa's legendary performance, featuring an excellent material transport system to process the job accurately and continuously. The next OPOS evolution is the OPOS Xtra alignment method, designed to handle irregular material deformation over the length of the print by adding extra XY lines between the designs. This method is especially beneficial for the processing of small sticker jobs.

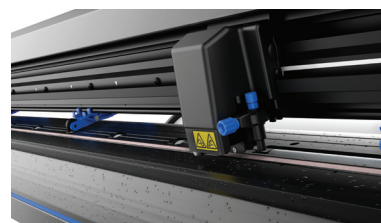

Summa S One Series line up

SUMMA S1 D60

The S1 D60 is Summa's smallest vinyl roll cutter and represents the ideal cutting solution for startup sign makers who want to automate their cutting workflow and extend their cutting applications. This handy-sized roll cutter might be small, but shows you great performances, day in day out.

Key Benefits

- Advanced cutting technology
- Ergonomic Design
- User-friendly features
- Latest alignment method
- Legendary tracking performance
- Connectivity options
- Summa GoSign software

Ideal to cut*:

- In- and outdoor signage
- Traffic signs
- Safety indications
- Vehicle and window lettering

* Materials must be validated by Summa



Video:
Scan the QR code to watch all the Summa videos

Technical Specifications

Model	S1 D60	
Dimensions	97 x 40.6 x 30.4 cm	
Media Width	7.9 to 70.5 cm	
Max. Working width Oversized mode*	59 cm x 50 m 65 cm x 50 m	
Alignment Type	<ul style="list-style-type: none"> • OPOS X - OPOS Xtra • Barcode job recognition 	<ul style="list-style-type: none"> • Up to 2 x 64 marks on the X-line • Y-Line compensation
Tracking Performance	8 m max. within guaranteed specifications for media less than 762 mm	4 m max. within guaranteed specifications for media larger than 762 mm
Accuracy	0.2% of move or 0.25 mm, whichever is greater	
Speed	Up to 1131 mm/s diagonal	
Acceleration	Up to 3 G diagonal	
Knife Pressure	0 to 600 gr	
Other Features	FlexCut (cutting through)	
Connectivity	Ethernet, USB, WiFi (region dependent)	
Power requirements	100-240 VAC, 50/60 Hz	
Included software	Summa GoSign Software, Summa Cutter Control	
*In 'Oversized' mode the tracking performance is no longer guaranteed.		

Media Add- Ons

The smallest S1 D60 model can be equipped and retrofitted with an optional stand or stand + basket. The mesh basket collects the cut media, preventing dust and debris from sticking onto the media. The basket also neatly organizes vinyl and other media when processing multiple jobs.

- Optional stand only
- Optional basket only
- Optional stand + basket
- Optional Tray One sheet feeder

Smart Features

The S One cutter is standard equipped with a range of convenient features, adding to the production efficiency and guaranteeing a perfectly cut product without hassle.

Enjoy an automated workflow and ease-of-use:

- Drag knife technology
- Coloured touchscreen
- Up to 600 gr of knife pressure
- Cutting accuracy with OPOS Xtra alignment
- Automation with the barcode workflow
- Up to 8 m tracking guaranteed
- FlexCut (cutting through)
- Connectivity: USB, Ethernet & WiFi (region dependent)
- Summa GoSign software
- Optional Tray One Sheet feeder: facilitating the processing of sheets and labels through automation



SUMMA S1 D120

The S1 D120 is the ideal intermediate size for many cutting jobs. All S One models were designed from the base with the user in mind. They represent the ideal cutting solution for sign makers who want to automate and level up their cutting workflow. The S One Series is your first choice where value and reliability are top of mind.

Key Benefits

- Advanced cutting technology
- Ergonomic design
- User-friendly features
- Latest alignment method
- Legendary tracking performance
- Connectivity
- Summa GoSign software

Ideal to cut*:

- In- and outdoor signage
- Traffic and advertising signs
- Safety indications
- Vehicle and window lettering

* Materials must be validated by Summa

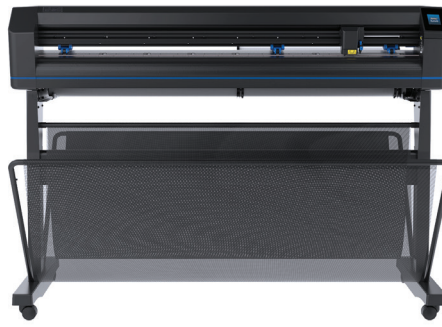

Video:
Scan the QR code to watch all the Summa videos

Technical Specifications

Model	S1 D120	
Dimensions	161.5 x 70.4 x 111.2. cm	
Media Width	13.3 to 135 cm	
Max. Working width Oversized mode*	123.5 cm x 50 m 129.5 cm x 50 m	
Alignment Type	<ul style="list-style-type: none"> • OPOS X - OPOS Xtra • Barcode job recognition 	<ul style="list-style-type: none"> • Up to 2 x 64 marks on the X-line • Y-Line compensation
Tracking Performance	8 m max. within guaranteed specifications for media less than 762 mm	4 m max. within guaranteed specifications for media larger than 762 mm
Accuracy	0.2% of move or 0.25 mm, whichever is greater	
Speed	Up to 1131 mm/s diagonal	
Acceleration	Up to 3 G diagonal	
Knife Pressure	0 to 600 gr	
Other Features	FlexCut (cutting through)	
Connectivity	Ethernet, USB, WiFi (region dependent)	
Power requirements	100-240 VAC, 50/60 Hz	
Included software	Summa GoSign Software, Summa Cutter Control	
*In 'Oversized' mode the tracking performance is no longer guaranteed.		

Media add-on

Summa S One vinyl cutters are designed with premium up-to-date components for long durability. On top of this, all models include a combination of integrated or optional media add-ons, to facilitate the operator's life.

- Stand included
- Basket included
- Extra pinch roller option available (factory installed)

Smart Features

The S One cutter is standard equipped with a range of convenient features, adding to the production efficiency and guaranteeing a perfectly cut product without hassle.

Enjoy an automated workflow and ease-of-use:

- Drag knife technology
- Coloured touchscreen
- Up to 600 gr of knife pressure
- Cutting accuracy with OPOS Xtra alignment
- Automation with the barcode workflow
- Up to 8 m/26 ft tracking guaranteed
- FlexCut (cutting through)
- Connectivity: USB, Ethernet & WiFi (region dependent)
- Summa GoSign software



SUMMA S1 D140 (FX)

The S1 D140 is the ideal intermediate size for many cutting jobs. All S One models were designed from the base with the user in mind. They represent the ideal cutting solution for sign makers who want to automate and level up their cutting workflow. The S One Series is your first choice where value and reliability are top of mind.

Key Benefits

- Advanced cutting technology
- Ergonomic design
- User-friendly features
- Latest alignment method
- Legendary tracking performance
- Connectivity
- Summa GoSign software

Ideal to cut*:

- In- and outdoor signage
- Traffic and advertising signs
- Safety indications
- Vehicle and window lettering

* Materials must be validated by Summa

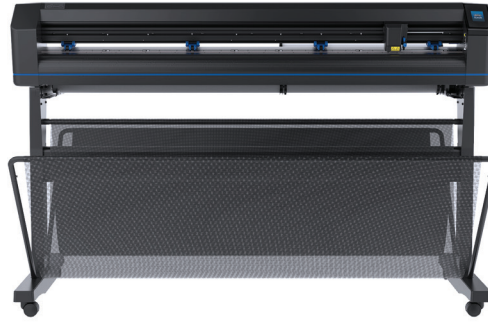

Video:
Scan the QR code to watch all the Summa videos

Technical Specifications

Model	S1 D140	
Dimensions	176.5 x 70.4 x 111.2. cm	
Media Width	18.7 to 150 cm	
Max. Working width Oversized mode*	138.5 cm x 50 m 144.5 cm x 50 m	
Alignment Type	<ul style="list-style-type: none"> • OPOS X - OPOS Xtra • Barcode job recognition 	<ul style="list-style-type: none"> • Up to 2 x 64 marks on the X-line • Y-Line compensation
Tracking Performance	8 m max. within guaranteed specifications for media less than 762 mm	4 m max. within guaranteed specifications for media larger than 762 mm
Accuracy	0.2% of move or 0.25 mm, whichever is greater	
Speed	Up to 1131 mm/s diagonal	
Acceleration	Up to 3 G diagonal	
Knife Pressure	0 to 600 gr	
Other Features	FlexCut (cutting through)	
Connectivity	Ethernet, USB, WiFi (region dependent)	
Power requirements	100-240 VAC, 50/60 Hz	
Included software	Summa GoSign Software, Summa Cutter Control	
*In 'Oversized' mode the tracking performance is no longer guaranteed.		

Smart Features

The S One cutter is standard equipped with a range of convenient features, adding to the production efficiency and guaranteeing a perfectly cut product without hassle.

Enjoy an automated workflow and ease-of-use:

- Drag knife technology
- Coloured touchscreen
- Up to 600 gr of knife pressure
- Cutting accuracy with OPOS Xtra alignment
- Automation with the barcode workflow
- Up to 8 m/26 ft tracking guaranteed
- FlexCut (cutting through)
- Connectivity: USB, Ethernet & WiFi (region dependent)
- Summa GoSign software

Fixed Position (FX)

The S1 D140FX model has fixed pinch roller positions, meaning any media size can be loaded but margins cannot be minimised. It is the ideal model for customers with a low workload where the direct cut method is not a focus.

Media Add- On

To facilitate the operator's life, all S One models include a combination of integrated or optional media add-ons.

- Stand included
- Basket included
- Extra pinch roller option available (factory installed)



SUMMA S1 D160

The S1 D160 is Summa's largest roll cutter size, offering great flexibility in the cutting workflow with the ability to process many job sizes. All S One models represent the ideal cutting solution for sign makers who want to automate and level up their cutting workflow. The S One Series is your first choice where value and reliability are top of mind.

Key Benefits

- Drag cutting technology
- Ergonomic design
- User-friendly features
- Latest alignment method
- Legendary tracking performance
- Connectivity
- Summa GoSign software

Ideal to cut*:

- In- and outdoor signage
- Traffic and advertising signs
- Safety indications
- Vehicle and window lettering

* Materials must be validated by Summa

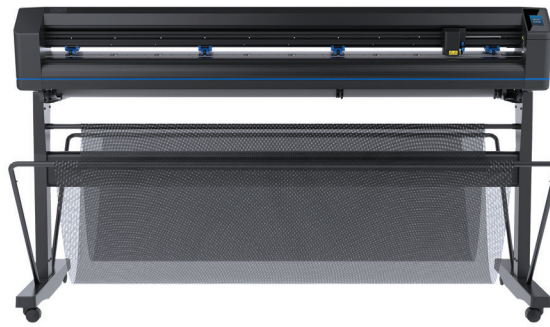

Video:
Scan the QR code to watch all the Summa videos

Technical Specifications

Model	S1 D160	
Dimensions	196 x 70.4 x 111.2. cm	
Media Width	18.7 to 169 cm	
Max. Working width Oversized mode*	158 cm x 50 m 164 cm x 50 m	
Alignment Type	<ul style="list-style-type: none"> • OPOS X - OPOS Xtra • Barcode job recognition 	<ul style="list-style-type: none"> • Up to 2 x 64 marks on the X-line • Y-Line compensation
Tracking Performance	8 m max. within guaranteed specifications for media less than 762 mm	4 m max. within guaranteed specifications for media larger than 762 mm
Accuracy	0.2% of move or 0.25 mm, whichever is greater	
Speed	Up to 1131 mm/s diagonal	
Acceleration	Up to 3 G diagonal	
Knife Pressure	0 to 600 gr	
Other Features	FlexCut (cutting through)	
Connectivity	Ethernet, USB, WiFi (region dependent)	
Power requirements	100-240 VAC, 50/60 Hz	
Included software	Summa GoSign Software, Summa Cutter Control	
*In 'Oversized' mode the tracking performance is no longer guaranteed.		

Smart Features

The S One cutter is standard equipped with a range of convenient features, adding to the production efficiency and guaranteeing a perfectly cut product without hassle.

Enjoy an automated workflow and ease-of-use:

- Drag knife technology
- Coloured touchscreen
- Up to 600 gr of knife pressure
- Cutting accuracy with OPOS Xtra alignment
- Automation with the barcode workflow
- Up to 8 m/26 ft tracking guaranteed
- FlexCut (cutting through)
- Connectivity: USB, Ethernet & WiFi (region dependent)
- Summa GoSign software

Media Add- On

Summa S One vinyl cutters are designed with premium up-to-date components for long durability. On top of this, all models include a combination of integrated or optional media add-ons, to facilitate the operator's life.

- Stand included
- Basket included
- Extra pinch roller option available (factory installed)



S ONE SPECIFICS

The Summa S One Series is built on a foundation of experience and commitment to offer top-of-the-line cutters at a wallet-friendly price. S One cutters use the popular drag-knife technique, where a high-speed cutting head, legendary tracking and an optical positioning system play a leading roll.

Drag Knife Technology

Drag or swivel technique is the most commonly used technique in the market to process designs for billboards, light boxes, window graphics and so on. However, depending on the media thickness, some distortions or deviations in the corners may occur by using this technique.

This is why Summa S One cutters include enhanced methods to avoid such distortions and optimise the drag movement in order to obtain the best possible cutting quality.



Drag movement

- 1 | The drag knife stops cutting before entering a corner.
- 2 | The eccentric blade is rotated by performing a drag movement to the desired angle, never leaving the media.
- 3 | Once the drag-movement is completed, the corner cutting continues.

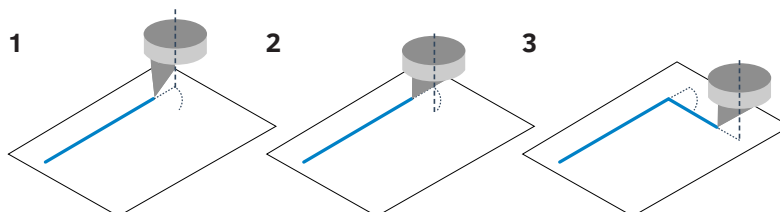

Internal Intelligence

Summa cutters are loaded with intelligent routines, optimising the cutting data. All Summa cutters use an advanced vector look-ahead technology that cuts complex images and lettering with improved efficiency. The cutting time is reduced considerably, curves are smoother, and the motors are less loaded, which increases the lifetime of the plotter. Other intelligent features include:

Overcut

OverCut extends the vector at the beginning and at the end of a curve. This ensures the design is cut through completely. Without the OverCut function, the cut line may not be completely closed, causing difficulties when weeding.

OptiCut

OptiCut, a function specially developed for drag knife cutters, simulates tangential cutting. Due to performance of complex movements, the OptiCut feature compensates for changes in the blade offset, caused by wear and tear. The OptiCut feature ensures the knife is orientated correctly. This revolutionary technology gives you optimal quality during your blade's lifetime.

Summa FlexCut

Summa's FlexCut feature enables you to cut simple designs completely through the material. Alternately, one length is cut completely through the material, and one length is cut halfway through. This way a kind of tear-off line is created, ensuring the material keeps a certain rigidity during transportation through the Summa cutter, while remaining easy to remove from the design afterwards.



Material Transport

Material transport is probably one of the most important issues when cutting vinyl. The slightest error can result in material waste, loss of time and operator frustrations. Summa offers an exquisite tracking system and extensive range of features to ensure your S One cutter performs perfectly and flawlessly. Each time again for many years to come.



Tray One Sheet Feeder for S1 D60

The Tray One sheet feeder enhances automation, facilitates media handling and saves the roll cutter operator a lot of time. Tray One is compatible and retrofittable with S1 D60 models from the Summa S One Series. The combination of our desktop roll cutters with a sheet feeder not only benefits large volume industries but equally focuses on small volume businesses, such as copy shops and retailers. By using Tray One, each copy/sheet will be cut straightforwardly and easily. Sheet after sheet. For hours in a row.



Notes: The Tray One sheet feeder is also retrofittable with SummaCut D60 models in the field.

Compatible with F Series Twin Workflow

To maximise productivity and flexibility in your finishing workflow, you can use the Twin Workflow. The Twin workflow combines the strength of a Summa roll cutter with an F Series flatbed cutter, meaning you can kiss-cut on the roll cutter and cut through on the F Series flatbed cutter.

The Twin Workflow has been developed for users that want to optimise the use of their equipment in a most efficient way. By using one of these workflows, productivity and performance will be brought to a higher level. The smooth integration of the cutters into existing workflows will further contribute to the customer's Productivity, Performance and Profitability!

Video: www.Summa.com/video/twin

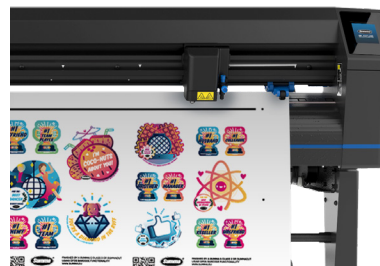

Registration Marks (OPOS Contour Cutting)

Summa's automated contour alignment system OPOS stands for Optical Positioning System. The OPOS sensor registers printed squares that are placed around the graphic. This allows OPOS to determine the exact position of the printed graphic and enables you to die-cut valuable printed and laminated vinyl graphics with complete confidence and ease.

OPOS X

The OPOS X feature, standard on all Summa models, automatically looks for the cross marks by using a sensor. The possibility to use multiple cross marks is a unique OPOS feature and guarantees the best possible accuracy. The OPOS X sensor even detects registration marks through dense laminated graphics with uneven texture and brings contour cutting to a much higher level.

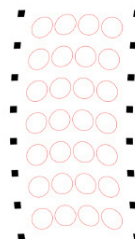

OPOS XY / OPOS XY2

The OPOS XY alignment method allows to measure a line across the print width, in addition to the OPOS marks. This will automatically adjust media curvature or deformation across the width of the print. The OPOS XY2 alignment method adds an extra measurement line at the rear of the print, allowing to compensate for any changes in print curvature between start and finish of your print job.

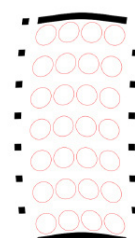
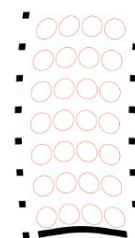

OPOS Barcode

The barcode reading functionality is a productivity tool. Multiple jobs can thus be processed without operator intervention. Also, the risk of sending the wrong data to the wrong print no longer exists. The OPOS X sensor reads the barcode and sends the correct job number to the computer. The computer then provides the matching cutting information which is immediately processed by the cutter. When the job is finished the cutter automatically starts looking for the next job and its barcode.

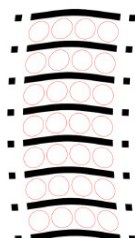

OPOS Xtra

The next evolution in OPOS is OPOS Xtra. This alignment mode is designed to handle irregular material deformation over the length of the print by adding additional XY lines between the designs. This increases the accuracy and alignment methodology for smaller stickers.

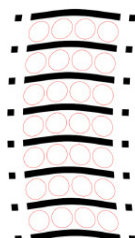

OPOS alignment systems are available for all models

TECHNICAL SPECIFICATIONS

Model	S1 D60	S1 D120	S1 D140	S1 D160
Dimensions	97 x 40.6 x 30.4 cm	161.5 x 70.4 x 111.2 cm	176.5 x 70.4 x 111.2 cm	196 x 70.4 x 111.2 cm
Media Width	7.9 to 70.5 cm	13.3 to 135 cm	18.7 to 150 cm	18.7 to 169 cm
Max. Working width Oversized mode*	59 cm x 50 m 65 cm x 50 m	123.5 cm x 50 m 129.5 cm x 50 m	138.5 cm x 50 m 144.5 cm x 50 m	158 cm x 50 m 164 cm x 50 m
Pinch rollers	2	3	4 (3 for FX)	4
Alignment Type	<ul style="list-style-type: none"> OPOS X - OPOS Xtra Barcode job recognition 		<ul style="list-style-type: none"> Up to 2 x 64 marks on the X-line Y-Line compensation 	
Tracking Performance	8 m max. within guaranteed specifications for media less than 762 mm 4 m max. within guaranteed specifications for media larger than 762 mm			
Accuracy	0.2% of move or 0.25 mm, whichever is greater			
Speed	Up to 1131 mm/s diagonal			
Acceleration	Up to 3 G diagonal			
Knife Pressure	0 to 600 gr			
Other Features	FlexCut (cutting through)			
Connectivity	Ethernet, USB, WiFi (region dependent)			
Power requirements	100-240 VAC, 50/60 Hz			
Included software	Summa GoSign™ Software, Summa Cutter Control, MacSign™ Cut Cutting Software			
*In 'Oversized' mode the tracking performance is no longer guaranteed.				



S1 D60

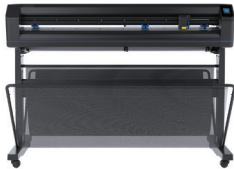

S1 D120

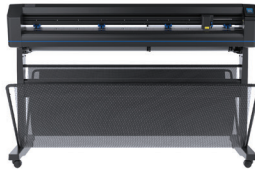

S1 D140



S1 D140 FX

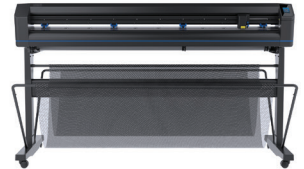

S1 D160

NOTES

SUMMA S CLASS 2 SERIES, BUILT TO PROVIDE THE VERY BEST IN CONTOUR CUTTING

S Class 2™ tangential and drag-knife cutters feature first-class engineering and advanced cutting technology to deliver astonishing contour cut accuracy for even the most challenging printed graphics. Summa S Class 2 cutters are built on a foundation of rock-solid reliability and include smart features to boost efficiency in your cutting workflow and grow along with your business needs and aspirations.

Leave nothing to chance and enjoy leading-edge contour cut excellence now and for many years to come!



Summa S Class 2 Series

Level up with advanced cutting technology

The sign industry has gone through a tremendous amount of change over the years. So, your cutting equipment needs to be able to adapt and be both flexible and durable. Summa S Class 2 cutters are built on a foundation of rock-solid reliability and offer features to enhance efficiency in the cutting workflow. Like the finely-tuned suspension in a sports car, our world-renowned precision tracking system puts even more power under the hood to increase performance and yield. Combine this with a powerful dual servomotor and the S Class 2 cutter is your future-proof and reliable companion for many years to come.

From cutting all sorts of vinyl to accurate, digital die-cutting to plotting on paper and beyond, the Summa S Class 2 cutter is a do-it-all cutter with the strength to perform day in and day out. The accuracy of our European-crafted cutters is precisely what makes them so durable. Trust the processing of your expensive foils and valuable vinyl prints to our reliable S Class 2 cutters and you will not regret it. Not ever.

Key features

S Class 2™ tangential and drag-knife cutters feature the highest quality engineering and most advanced cutting technology. A broad range of integrated and optional features further enhance your cutting workflow and production to deliver perfectly cut end products fast and efficiently.

True Tangential cutting technology

The highly-engineered tangential cutting heads on the S Class 2 T Series power through heavy sandblast, paint mask and reflective materials with incredible ease, speed and accuracy.

These exclusive cutting heads provide you with unrivalled, True Tangential Technology and unmatched die-cutting precision as no other in its class.

G-Performance

This mode is designed to enhance the speed and performance of digital finishing operations on the S2 roll cutters up to 40%. This is especially noticeable on a faster reading of the registration marks and when cutting wider substrates. Especially within large industrial environments, the G-performance mode will prove its worth and give your overall workflow a serious boost.

Fast and accurate cutting with OPOS CAM

The camera recognition alignment solution - OPOS CAM - allows customers in volume-driven workflow environments to excel with extremely fast precision and accurate cutting of short or long run contour cutting jobs.

Summa GoSign software

Powerful in-house GoSign software, allows you to manage your preferred workflow straightforwardly and with great flexibility.

Legendary performance

Reliable material transport through Summa's legendary tracking system combined with the smart OPOS Xtra feature guarantees meticulous processing of very small sticker jobs.

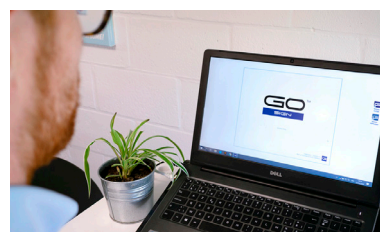
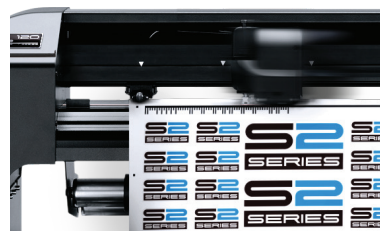

Summa S Class 2 Series line up

SUMMA S2 75

The S2 75 is Summa's smallest vinyl roll cutter from the S2 Series and represents the ideal cutting solution for startup sign makers who want to automate their cutting workflow and extend their cutting applications.

Key Benefits

- Advanced cutting technology
- Ergonomic design
- User-friendly features
- Legendary tracking performance
- Connectivity
- Summa GoSign software

Ideal to cut:

- Reflective, holographic, mirroring materials
- In- and outdoor signage
- Traffic and advertising signs
- Safety indications
- Vehicle and window lettering



Video:
Scan the QR code to watch all the Summa videos

Technical Specifications

Model	S2 75	
Dimensions	141 x 68 x 111 cm	
Media Width	6 to 84 cm	
Max. Working width	74.2 cm x 50 m 'Oversized' mode allows a wider cutting area: +/-7 cm	
Alignment Type	<ul style="list-style-type: none"> • OPOS X - OPOS Xtra • OPOS - CAM (factory upgrade) • Barcode job recognition 	<ul style="list-style-type: none"> • Up to 2 x 64 marks on the X-line • Y-Line compensation
Tracking Performance	12 m max. within guaranteed specifications for media less than 760 mm	4 m max. within guaranteed specifications for media larger than 760 mm
Accuracy	0.2% of move or 0.25 mm, whichever is greater	
Speed	Up to 1410 mm/s diagonal	
Acceleration	Up to 5.5 G diagonal	
Knife Pressure	Drag Knife: Up to 400 grams / Tangential Knife: Up to 600 grams	
Other Features	FlexCut (cutting through)	
Connectivity	Ethernet, USB	
Power requirements	100-120 / 220-240 VAC, 50/60 Hz, 85 VA maximum	
Included software	Summa GoSign Software, Summa Cutter Control	
*In 'Oversized' mode the tracking performance is no longer guaranteed.		

Advanced Cutting Head Technology

The S2™ D Series unites legendary S Class power and precision with an efficient and affordable drag knife cutting head. The S2™ T Series features a state-of-the-art True Tangential™ cutting head, cutting with more force and accuracy than any other cutter in its class.

All S2 models are designed with premium components and show resilience to perform day in and day out.

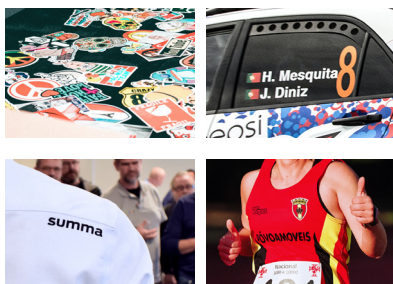

Smart Features

The S2 Series is standard equipped with a range of convenient features, adding to the production efficiency and guaranteeing a perfectly cut product without hassle.

Enjoy an automated workflow and ease-of-use:

- Tangential or drag knife technology
- Up to 600 gr of knife pressure
- Cutting accuracy with OPOS Xtra alignment
- G-Performance (optional)
- Automation with the barcode workflow
- Up to 40 ft. tracking guaranteed
- Connectivity: USB, Ethernet
- Summa GoSign software



SUMMA S2 120

The S2 120 is the ideal intermediate size for many cutting jobs. All S2 models were designed on a foundation of unrivalled technology and reliability. Enjoy leading-edge cutting performance to deliver precisely cut products. Fast and straightforwardly.

Key Benefits

- Advanced cutting technology
- Ergonomic design
- User-friendly features
- Latest alignment method
- Legendary tracking performance
- Connectivity
- Summa GoSign software

Ideal to cut:

- Reflective, holographic, mirroring materials
- In- and outdoor signage
- Traffic and advertising signs
- Safety indications
- Vehicle and window lettering



Video:
Scan the QR code to watch all the Summa videos

Technical Specifications

Model	S2 120	
Dimensions	187 x 68 x 111 cm	
Media Width	12 to 130 cm	
Max. Working width	120 cm x 50 m 'Oversized' mode allows a wider cutting area: +/-7 cm	
Alignment Type	<ul style="list-style-type: none"> • OPOS X - OPOS Xtra • Barcode job recognition 	<ul style="list-style-type: none"> • Up to 2 x 64 marks on the X-line • Y-Line compensation
Tracking Performance	12 m max. within guaranteed specifications for media less than 760 mm	4 m max. within guaranteed specifications for media larger than 760 mm
Accuracy	0.2% of move or 0.25 mm, whichever is greater	
Speed	Up to 1410 mm/s diagonal	
Acceleration	Up to 5.5 G diagonal	
Knife Pressure	Drag Knife: Up to 400 grams / Tangential Knife: Up to 600 grams	
Other Features	FlexCut (cutting through)	
Connectivity	Ethernet, USB	
Power requirements	100-120 / 220-240 VAC, 50/60 Hz, 85 VA maximum	
Included software	Summa GoSign Software, Summa Cutter Control	
*In 'Oversized' mode the tracking performance is no longer guaranteed.		

Advanced Cutting Head Technology

The S2™ D Series unites legendary S Class power and precision with an efficient and affordable drag knife cutting head. The S2™ T Series features a state-of-the-art True Tangential™ cutting head, cutting with more force and accuracy than any other cutter in its class.

All S2 models are designed with premium components and show resilience to perform day in and day out.

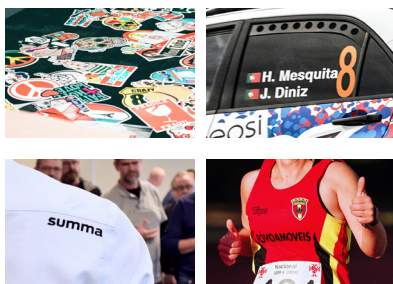

Smart Features

The S2 Series is standard equipped with a range of convenient features, adding to the production efficiency and guaranteeing a perfectly cut product without hassle.

Enjoy an automated workflow and ease-of-use:

- Tangential or drag knife technology
- Up to 600 gr of knife pressure
- Cutting accuracy with OPOS Xtra alignment
- G-Performance (optional)
- Automation with the barcode workflow
- Up to 40 ft. tracking guaranteed
- Connectivity: USB, Ethernet
- Summa GoSign software



SUMMA S2 140

The S2 140 is the ideal intermediate size for many cutting jobs. All S2 models were designed on a foundation of unrivalled technology and reliability. Enjoy leading-edge cutting performance to deliver precisely cut products. Fast and straightforwardly.

Key Benefits

- Advanced cutting technology
- Ergonomic design
- User-friendly features
- Latest alignment method
- Legendary tracking performance
- Connectivity
- Summa GoSign software

Ideal to cut:

- Reflective, holographic or mirroring materials
- In- and outdoor signage
- Traffic and advertising signs
- Safety indications
- Vehicle and window lettering



Video:
Scan the QR code to watch all the Summa videos

Technical Specifications

Model	S2 140	
Dimensions	202 x 68 x 111 cm	
Media Width	17 to 145 cm	
Max. Working width	135 cm x 50 m 'Oversized' mode allows a wider cutting area: +/-7 cm	
Alignment Type	<ul style="list-style-type: none"> • OPOS X - OPOS Xtra • Barcode job recognition 	<ul style="list-style-type: none"> • Up to 2 x 64 marks on the X-line • Y-Line compensation
Tracking Performance	12 m max. within guaranteed specifications for media less than 760 mm	4 m max. within guaranteed specifications for media larger than 760 mm
Accuracy	0.2% of move or 0.25 mm, whichever is greater	
Speed	Up to 140 mm/s diagonal	
Acceleration	Up to 5.5 G diagonal	
Knife Pressure	Drag Knife: Up to 400 grams / Tangential Knife: Up to 600 grams	
Other Features	FlexCut (cutting through)	
Connectivity	Ethernet, USB	
Power requirements	100-120 / 220-240 VAC, 50/60 Hz, 85 VA maximum	
Included software	Summa GoSign Software, Summa Cutter Control	
*In 'Oversized' mode the tracking performance is no longer guaranteed.		

Advanced Cutting Head Technology

The S2™ D Series unites legendary S Class power and precision with an efficient and affordable drag knife cutting head. The S2™ T Series features a state-of-the-art True Tangential™ cutting head, cutting with more force and accuracy than any other cutter in its class.

All S2 models are designed with premium components and show resilience to perform day in and day out.

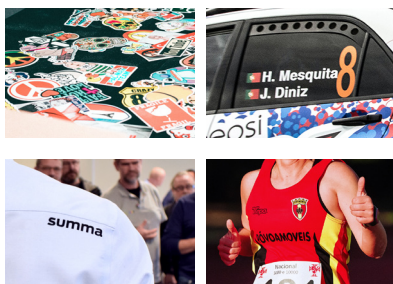

Smart Features

The S2 Series is standard equipped with a range of convenient features, adding to the production efficiency and guaranteeing a perfectly cut product without hassle.

Enjoy an automated workflow and ease-of-use:

- Tangential or drag knife technology
- Up to 600 gr of knife pressure
- Cutting accuracy with OPOS Xtra alignment
- G-Performance (optional)
- Automation with the barcode workflow
- Up to 40 ft. tracking guaranteed
- Connectivity: USB, Ethernet
- Summa GoSign software



SUMMA S2 160

The S2 160 is Summa's largest S2 roll cutter size, offering great flexibility in the cutting workflow with the ability to process many job sizes. All S2 models were designed on a foundation of unrivalled technology and reliability. Enjoy leading-edge cutting performance to deliver flawlessly cut products. Fast and straightforward.

Key Benefits

- Advanced cutting technology
- Ergonomic design
- User-friendly features
- Latest alignment method
- Legendary tracking performance
- Connectivity
- Summa GoSign software

Ideal to cut:

- Reflective, holographic or mirroring materials
- In- and outdoor signage
- Traffic and advertising signs
- Safety indications
- Vehicle and window lettering



Video:
Scan the QR code to watch all the Summa videos

Technical Specifications

Model	S2 160	
Dimensions	225 x 68 x 111 cm	
Media Width	17 to 168 cm	
Max. Working width	158 cm x 50 m 'Oversized' mode allows a wider cutting area: +/-7 cm	
Alignment Type	<ul style="list-style-type: none"> • OPOS X - OPOS Xtra • OPOS - CAM (factory upgrade) • Barcode job recognition 	<ul style="list-style-type: none"> • Up to 2 x 64 marks on the X-line • Y-Line compensation
Tracking Performance	12 m max. within guaranteed specifications for media less than 760 mm	4 m max. within guaranteed specifications for media larger than 760 mm
Accuracy	0.2% of move or 0.25 mm, whichever is greater	
Speed	Up to 1410 mm/s diagonal	
Acceleration	Up to 5.5 G diagonal	
Knife Pressure	Drag Knife: Up to 400 grams / Tangential Knife: Up to 600 grams	
Other Features	FlexCut (cutting through)	
Connectivity	Ethernet, USB	
Power requirements	100-120 / 220-240 VAC, 50/60 Hz, 85 VA maximum	
Included software	Summa GoSign Software, Summa Cutter Control	
*In 'Oversized' mode the tracking performance is no longer guaranteed.		

Smart Features

The S2 Series is standard equipped with a range of convenient features, adding to the production efficiency and guaranteeing a perfectly cut product without hassle.

Enjoy an automated workflow and ease-of-use:

- Tangential or drag knife technology
- Up to 600 gr of knife pressure
- Cutting accuracy with OPOS Xtra alignment
- G-Performance (optional)
- Automation with the barcode workflow
- Up to 40 ft. tracking guaranteed
- Connectivity: USB, Ethernet
- Summa GoSign software

Advanced Cutting Head Technology

The S2™ D Series unites legendary S Class power and precision with an efficient and affordable drag knife cutting head. The S2™ T Series features a state-of-the-art True Tangential™ cutting head, cutting with more force and accuracy than any other cutter in its class.

All S2 models are designed with premium components and show resilience to perform day in and day out.

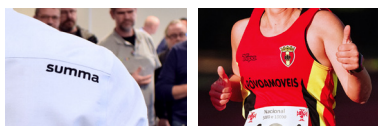

S CLASS 2 SPECIFICS

All specifications applicable on the S One Series are also applicable on the S Class 2 Series. Built on a foundation of experience and commitment to offer top-of-the-line cutters to grow with your business and last for many years to come.

S Class 2 T Series

The Summa S Class 2 T Series combines S Class power and precision with a state-of-the-art True Tangential™ cutting head.

Coupled with an astonishing array of innovations and built-in capabilities, this plotter offers you to best there is in roll cutting.



Tangential Cutting Head

T Series | Tangential Cutting Head

Featuring computer-controlled blade rotation and up to 600 grams of cutting force, Summa's T Series combines the precision of a flatbed cutter with the ease and speed of a roll-fed cutter by using our legendary True Tangential cutting head. The T Series simply cuts with more force and accuracy than any cutter in its class.



Key Strengths

- Unique to Summa technology
- Accurate depth control
- Perfect to cut Thick, Thin and Tough material
- Accurate results in corners and the tiniest of details



Tangential movement

1 | The Tangential Knife stops cutting right before a corner.

2 | A motor lifts and re-orientates the blade.

3 | Once the blade has reached the desired angle, it is lowered and continues to cut the corner.

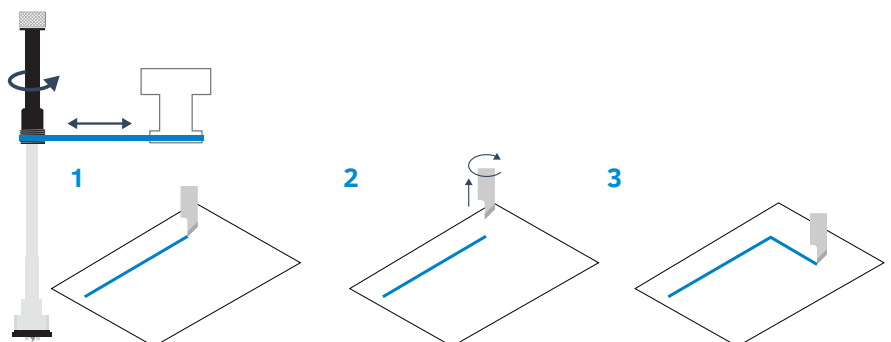

S Class 2 D Series

Summa S2™ D Series vinyl cutters are specifically designed for high-volume cutting environments. They unite legendary S Class power and precision with an efficient and affordable drag knife cutting head. Boasting an astonishing array of industry-first innovations and built-in capabilities, the S2™ D Series is a do-it-all dynamo with the resilience to perform day in and day out.



S Class 2 OPOS CAM Series for S2 T75 & S2 T160

Summa's Tangential module, combined with an OPOS CAMera offers state-of-the-art registration mark recognition at lightning-fast speeds. Summa OPOS CAM roll cutters are, therefore, cutting-edge and unmatched in many Print&Cut workflows.

- Unique True Tangential cutting technology
- Higher accuracy by placing 'infield' registration marks
- Accurate fixed-size cutting with 'Fixed size mode'
- Job segmentation to preserve the best tracking performance
- Mark registration about 10 times faster than any light sensor
- Custom camera profile to process challenging media types
- Available as factory upgrade for Summa S Class 2 T75 & T160
- Requires a USB connection with Summa Cutter Control (Windows)

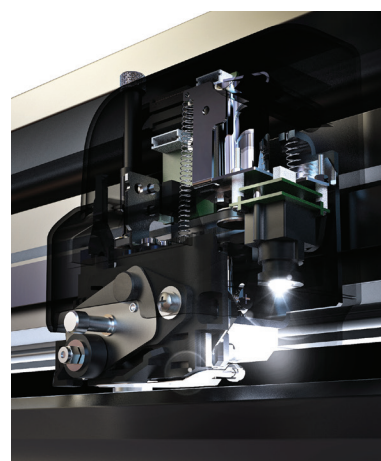

“I truly believe that the purchase of the Summa vinyl cutter back in 2016 was in many ways a good move. It helped us to reach higher quality levels, thus contributing to lift our business to the next level.”

/ Industria Graphica FG about investing in a Summa S Class 2 T160



Dual Head

As an option, the S Class 2 T Series can be equipped with a cutting head with dual functionality. This special Dual Head features an extra pen adaptor, instead of the OPOS sensor, allowing you to work alternately with each tool.

The perfect solution for drawing and cutting patterns in one easy step!



G-Performance Mode (Optional)

By using this mode, you can boost the production speed on the S Class 2 roll cutters by up to 40%, depending on the type of cutting job. Its impact is especially noticeable on a faster reading of the registration marks and when cutting wider substrates. As a result, default jobs are handled much faster than average. G-performance is offered for users who want to step up their yield and process jobs that can handle higher than average speeds.



Summa FlexCut

Summa's FlexCut feature enables you to cut simple designs completely through the material. Alternately, one length is cut completely through the material, and one length is cut halfway through. This way a kind of tear-off line is created, ensuring the material keeps a certain rigidity during transportation through the Summa cutter, while remaining easy to remove from the design afterwards.



Material Transport

A smooth transportation of the material is undoubtedly one of the most important issues when vinyl cutting. The exclusive Summa MicroSprocket drive drum tracks full rolls without skewing. This way, absolute cutting accuracy is guaranteed up to 12 meters in length, enabling to cut long or various designs subsequently without the need to reload. Durable titanium coated grit rollers assure job continuity for many years to come with the best tracking system available on the market.

Media Options

A servo-powered roll-up system for S2 140 & S2 160

After a job is finished, the system will roll up the artwork neatly and prepare the machine for the next unattended job. The integrated paneling feature splits long-length runs into shorter consecutive jobs, allowing to cut complete rolls unattended and deliver the output nicely rolled-up.



Servo-powered roll-up system

A solid, most effective media rack for S2 140 & S2 160

Store your media rolls effectively and keep your work environment neat and tidy with the optional media rack. Note: The roll-up system and the media rack cannot be combined.



Media rack

Extra pinch rollers

Extra pinch rollers can be factory installed or retrofitted when required in order to obtain more grip (middle pinch roller only).

Compatible with F Series Twin Workflow

To maximise productivity and flexibility in your finishing workflow, you can use the Twin Workflow. The Twin workflow combines the strength of a Summa roll cutter with an F Series flatbed cutter, meaning you can kiss-cut on the roll cutter and cut through on the F Series flatbed cutter.

The Twin Workflow has been developed for users that want to optimise the use of their equipment in a most efficient way. By using one of these workflows, productivity and performance will be brought to a higher level. The smooth integration of the cutters into existing workflows will further contribute to the customer's Productivity, Performance and Profitability!

Video: www.Summa.com/video/twin

Registration Marks (OPOS Contour Cutting)

Summa's automated contour alignment system OPOS stands for Optical Positioning System. The OPOS sensor registers printed squares that are placed around the graphic. This allows OPOS to determine the exact position of the printed graphic and enables you to die-cut valuable printed and laminated vinyl graphics with complete confidence and ease.

OPOS X

The OPOS X feature, standard on all Summa models, automatically looks for the cross marks by using a sensor. The possibility to use multiple cross marks is a unique OPOS feature and guarantees the best possible accuracy. The OPOS X sensor even detects registration marks through dense laminated graphics with uneven texture and brings contour cutting to a much higher level.

OPOS XY / OPOS XY2

OPOS XY allows to measure a line across the print width, additionally to the OPOS marks. This will automatically adjust media curvature or deformation across the width of the print. The OPOS XY2 alignment method adds an extra measurement line at the rear of the print, allowing to compensate for any changes in print curvature between start and finish of your print job.

OPOS Barcode

The barcode reading functionality is a productivity tool, allowing to process multiple jobs without operator intervention. Also, the risk of sending the wrong data to the wrong print no longer exists. The OPOS X sensor reads the barcode and sends the correct job to the computer. The computer returns the matching cutting information which is then processed by the cutter. When the job is finished, the cutter automatically starts looking for the next job and its barcode.

OPOS Xtra

A next evolution in OPOS is OPOS Xtra. This alignment mode is designed to handle irregular material deformation over the length of the print by adding additional XY lines between the designs. This increases the accuracy and alignment methodology for smaller stickers.

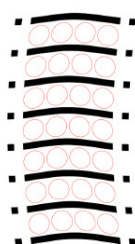
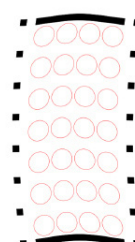
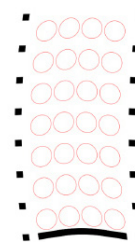
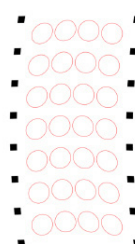
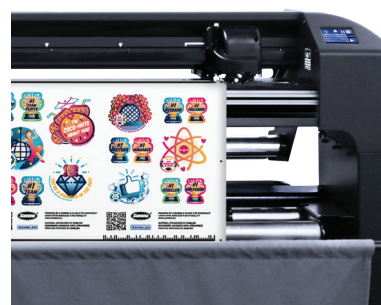

TECHNICAL SPECIFICATIONS

Model	S2 75	S2 120	S2 140	S2 160
Dimensions	141 x 68 x 111 cm	187 x 68 x 111 cm	202 x 68 x 111 cm	225 x 68 x 111 cm
Media Width	6 to 84 cm	12 to 130 cm	17 to 145 cm	17 to 168 cm
Max. Working width Oversized mode*	74.2 cm x 50 m	120 cm x 50 m	135 cm x 50 m	158 cm x 50 m
	'Oversized' mode allows a wider cutting area : +/- 7 cm*			
Pinch rollers	2	3	4	4
Alignment Type	<ul style="list-style-type: none"> OPOS X - OPOS Xtra OPOS CAM : Factory upgrade on new Summa S Class 2 S75T and S160T 		<ul style="list-style-type: none"> Barcode job recognition Up to 2 x 64 marks on the X-line Y-Line compensation 	
Tracking Performance	Within +/- 0.1 mm on plots: <ul style="list-style-type: none"> up to 12 m long on rolls up to 760 mm wide* up to 4 m long on rolls over 760 mm wide* 			
Accuracy	0.2% of move or 0.25 mm, whichever is greater			
Speed	Up to 1410 mm/s diagonal			
Acceleration	Up to 5.5 G diagonal			
Knife Pressure	Drag Knife: Up to 400 grams / Tangential Knife: Up to 600 grams			
Other Features	FlexCut (cutting through)			
Connectivity	Ethernet, USB			
Power requirements	100-120 / 220-240 VAC, 50/60 Hz, 85 VA maximum			
Included software	Summa GoSign™ Software, Summa Cutter Control, MacSign™ Cut Cutting Software			
*In 'Oversized' mode the tracking performance is no longer guaranteed.				



Summa Vinyl Cutters Comparison		S One FX Series	S One Series	S Class 2 D series	S Class 2 T series	S Class 2 OPOS CAM series
Maximum Media Width	60	-	70.5 cm	-	-	-
	75	-	-	84 cm	84 cm	84 cm
	120	-	135 cm	130 cm	130 cm	-
	140	142 cm	150 cm	145 cm	145 cm	-
	160	-	169 cm	168 cm	168 cm	168 cm
Cutting Technology	Drag Knife	Drag Knife	Drag Knife	True Tangential Knife	True Tangential Knife	
Opos X	✓	✓	✓	✓	✓	
Opos Xtra	✓	✓	✓	✓	✓	
Camera (USB)	-	-	-	-	✓	
Barcode Support	✓	✓	✓	✓	✓	
Roll-up	-	-	Optional	Optional	Optional	
Velocity	**	***	****	*****	*****	
Flexible Working Sizes	-	✓	✓	✓	✓	



SUMMA IN-HOUSE DEVELOPED SOFTWARE

The Summa GoSuite software platform has been developed in-house to enable users to make the most of their print and cut workflow. With the Summa software, operators, designers and business owners, can easily process and analyse complex and high volume jobs with great flexibility.

Rely on powerful software to maximise the use of your Summa cutting equipment.



Summa GoSign™

GoSign is your first choice cutting software designed for the Summa roll cutters. It allows you to manage your preferred workflow with great flexibility. Enjoy automated cutting options, custom configuration of action sets, easy plug-ins for design programs and much more.



The software GoSign that comes with the machines includes many features to keep you going and will expand further in the future. For a small additional charge, a Pro pack can be purchased, providing even more functionality to accommodate to your growing business.

- Modern interface
- Improved navigation
- Quick and intuitive
- Customised to your needs
- Standard available on website
- Pro Pack option available
- Windows-based

Build a cutting workflow to your preference

- Workflow automation, minimising operator intervention substantially.
- Increased flexibility with the option to cut directly from Adobe Illustrator or CorelDRAW.
- Material manager with your most commonly used materials and the possibility to add other material types along the way.
- Enhanced file compatibility, providing perfect synergy between hardware and software. Choose your preferred import method – by colour or by layer name.
- Availability of job log functionality, adding to the Summa roll cutters Industry 4.0 compatibility.
- Compatible with: DXF files, PLT files, files from open source design programs, such as Inkscape and many more.
- Customise action sets tailored to your specific workflow needs.

TIP | Scan the QR code to watch the GoSign video on Summa's Youtube page.



GoSign™ Pro Pack

The optional GoSign Pro Pack offers you advanced features such as barcode functionality, hot folder support and import possibility of plot files. Similar to the standard GoSign software, also the Pro Pack will be gradually expanded with new functionalities.

GoSign 2.0	GoSign 2.0 Pro Pack
Standard available on www.Summa.com	One-time Pro version purchase (395-995)
<ul style="list-style-type: none"> • All common functionalities specific to cutting programs: sorting, weeding box, multi-copy, ... • Custom configuration of action sets • Plug-ins for Adobe Illustrator and CorelDRAW • Material Manager • Job log functionality 	<ul style="list-style-type: none"> • All common functionalities specific to cutting programs: sorting, weeding box, multi-copy, ... • Custom configuration of action sets • Plug-ins for Adobe Illustrator and CorelDRAW • Material Manager • Job log functionality • Camera recognition • Twin workflow • Barcode functionality • Hot folder job handling • Import of plot files

Product Registration

Summa recommends users to register their products online. Upon registration of your Summa products, you can activate several features such as the G-Performance, barcode, and so on. Also, in the registration form, you can choose to tick the box if you want to receive our monthly newsletter. This way, you can stay up to date with Summa's latest products and features that might complement your cutting equipment.

All Summa products can be registered through the Summa website:
www.Summa.com/support/product-registration

Inspiring Customer Stories

Customer stories capture an extensive range of end-user experiences. Experiences they gain by operating our Summa cutting equipment daily, week in week out, year in year out. These stories will help you in obtaining a better understanding of the many reasons why a Summa product might just be the game changer you were looking for to bring your cutting workflow to the highest possible level.

Customer stories go beyond product leaflets, brochures and other presentations. These real-life views and opinions from people in the field are the actual depiction of a product's benefits as shown in a true production area. So, go ahead and read our blog, which is filled with inspiring customer stories to create innovative and striking applications with our Summa equipment that fits your every cutting need!

Blog: www.Summa.com/blog

Testimonial | Stickers and Posters.com

"WE WOULDN'T BE ABLE TO RUN SUCH INCREDIBLE PRODUCTION WITHOUT THE SUMMA VINYL CUTTERS."

Company: Stickers and Posters.com

Core business:
One-off-design stickers

Challenge:
Fast cutting in high volume

Solution: 6 Summa S Class 2 T160

The Story | Each day, thousands of 'one-off-design' stickers go through production at lightning speed. Customer demand for stickers and posters increased dramatically along with the growing online market. A great business opportunity. So, Stickers and Posters decided to invest in 6! S Class 2 T160 cutters with the True Tangential cutting technology to meet and exceed customer expectations. With this purchase, they are now able to finish out-of-the-box tasks, perfectly tailored to their customers' needs.



"I remember that we were literally taken back by both the speed and incredible accuracy during the kiss-cutting process of the stickers on the S Class 2 vinyl cutter model. More so, we appreciate the ease of set-up and operation efficiency with the onboard tracking mechanism, combined with the ability to work continuously. So, ultimately we paired up a Summa S2T160 vinyl cutter to each of the HP latex printers to keep the workflow equal and smoothly flowing."

/ Stickers and Poster about investing in 6 Summa S Class 2 T160

S ONE SERIES™ S CLASS 2 SERIES™



**World renowned vinyl
and contour cutters**

Summa nv
Rochesterlaan 6
8470 Gistel
Belgium

www.Summa.com

Summa America
100 Cummings Center
Suite #151-G
Beverly MA 01915
USA

Follow us on LinkedIn | Facebook | Twitter | YouTube | #SummaFinish

Copyright 2023© Summa nv. Marketing Communications. Summa nv believes that all illustrations and specifications contained in this catalogue are correct at the time of publication. Summa nv reserves the right to make changes at any time, without notice. RevEN23.02 / All rights reserved

